

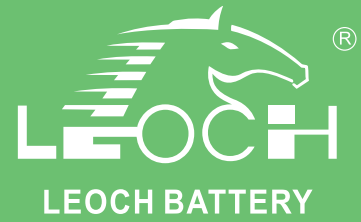

# PLC-Pure Lead Long Cycle Life PLC 100FT (12V90Ah)



## Specifications

Rated Voltage	12V	
Nominal Capacity	C <sub>10</sub> , 1.80V/cell	90Ah
	C <sub>20</sub> , 1.80V/cell	96.6Ah
Dimension	Length	397±2mm (15.6 inches)
	Width	108±2mm (4.25 inches)
	Container Height	278±2mm (11.3 inches)
	Total Height	278±2mm (11.3 inches)
Approx. Weight	31.0 Kg (68.2 lbs)	
Terminal	M8	
Container Material	PC-ABS flame retardant jar and cover to UL94 V-0	
Rated Capacity (25°C)	96.6 Ah	(20hr, 4.83A, 1.80V/cell)
	90.0 Ah	(10hr, 9.00A, 1.80V/cell)
	77.5 Ah	(5hr, 15.5A, 1.75V/cell)
	72.6 Ah	(3hr, 24.2A, 1.75V/cell)
	64.0 Ah	(1hr, 64.0A, 1.60V/cell)
Max. Discharge Current	1250A	
Internal Resistance (25°C)	Approx. 4.5mΩ(Fully charged)	
Operating Temp. Range	Discharge	-40 ~ 65°C (-40 ~ 149°F)
	Charge	0 ~ 54°C (32 ~ 129°F)
	Storage	-20 ~ 40°C (-4 ~ 104°F)
Nominal Operating Temp. Range	25±3°C (77±5°F)	
Max. Charging Current(25°C)	27.0A	
Charge voltage(25°C)	Float	13.62V
	Temp. Coefficient	-3mV/cell/°C
	Equalization(Cycle)	14.1~14.4V
Effect of temp. to Capacity	40°C (104°F)	103%
	25°C (77°F)	100%
	0°C (32°F)	86%
Self Discharge	<p>PIC series batteries can be stored up to 24 months at 25°C(77°F), For higher temperatures the time interval will be shorter.            Battery needs to be given a freshening charge when the OCV approach 2.10V/cell or when the maximum storage time is reached, whichever occurs first.</p>	



## Layout

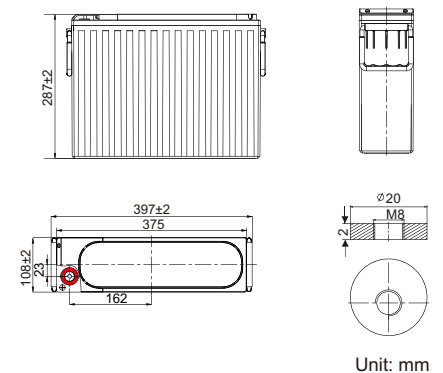

## Constant Current Discharge (Amperes) at 25 °C (77°F)

F.V/Time	10min	15min	20min	30min	45min	1h	2h	3h	4h	5h	8h	10h	20h
1.85V/cell	137.0	125.3	110.8	84.2	62.1	50.6	30.2	22.0	17.4	14.6	10.2	8.57	4.60
1.80V/cell	154.6	135.8	118.4	90.2	67.3	54.6	32.1	23.2	18.3	15.4	10.7	9.00	4.83
1.75V/cell	167.7	143.7	124.3	95.4	70.2	56.4	32.7	23.6	18.5	15.5	10.8	9.10	4.88
1.70V/cell	181.4	153.0	129.8	98.7	72.4	57.8	33.2	23.8	18.7	15.7	10.9	9.16	4.92
1.67V/cell	191.4	159.8	133.9	101.6	74.3	59.2	33.6	24.1	18.9	15.8	11.0	9.22	4.95
1.60V/cell	200.4	165.7	138.0	104.3	75.7	60.3	34.1	24.4	19.2	16.0	11.1	9.27	4.97

## Constant Power Discharge (Watts/cell) at 25 °C (77°F)

F.V/Time	10min	15min	20min	30min	45min	1h	2h	3h	4h	5h	8h	10h	20h
1.85V/cell	260.4	239.7	213.2	164.0	122.6	100.3	60.3	44.2	35.1	29.5	20.7	17.4	9.39
1.80V/cell	289.6	256.3	225.6	174.4	132.3	107.8	63.8	46.3	36.7	30.9	21.7	18.2	9.82
1.75V/cell	310.7	268.6	234.9	183.1	136.9	110.5	64.8	46.9	37.0	31.1	21.8	18.4	9.90
1.70V/cell	332.2	283.5	242.9	187.8	140.4	112.7	65.4	47.2	37.3	31.3	22.0	18.5	9.93
1.67V/cell	344.9	292.4	248.6	192.5	143.4	114.8	66.0	47.5	37.6	31.5	22.1	18.5	10.0
1.60V/cell	353.5	297.7	251.8	195.1	144.5	116.0	66.4	47.7	37.7	31.7	22.1	18.5	10.0



# PLC-Pure Lead Long Cycle Life

## PLC 100FT (12V90Ah)

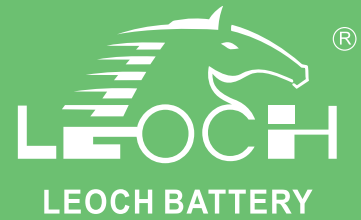

### Applications

- Unstable Grid System
- UPS System
- Renewable Energy System

### General Features

- 15 years design life(25°C)
- Outstanding high rate charge capability with Thin Plate Pure Lead technology
- High-rate performance, high energy density
- Virgin pure lead plates / copper alloy
- High quality AGM separators minimize electrical resistance to allow high current discharging properties.

### Standards

- Compliance with IEC 60896 standards
- UL, CE Certified
- Manufactured in Leoch@IATF16949, OHSAS 18001, ISO 9001 and ISO 14001 certified production facilities

### Discharge Characteristics

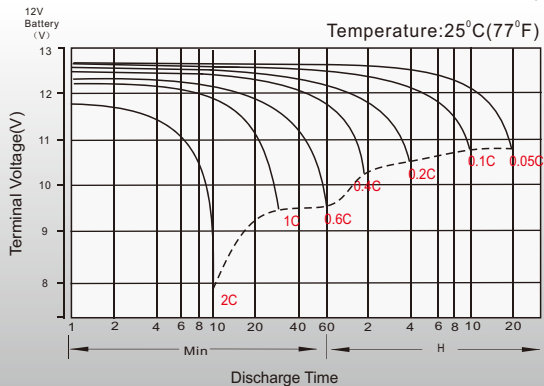

### Float Charging Characteristics

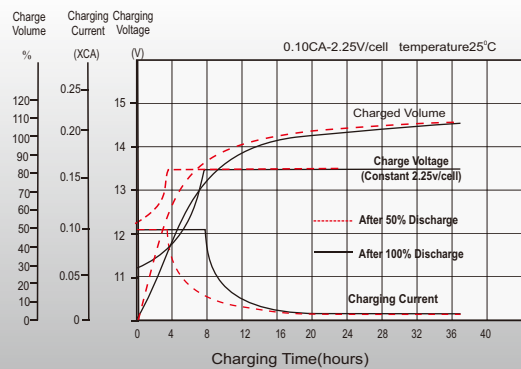

### Cycle Life vs. Depth of Discharge

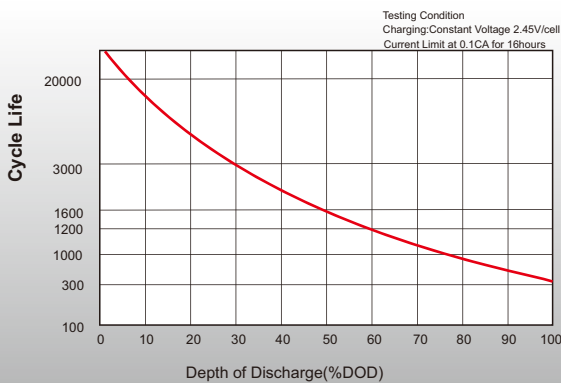

### Self-discharge Characteristics

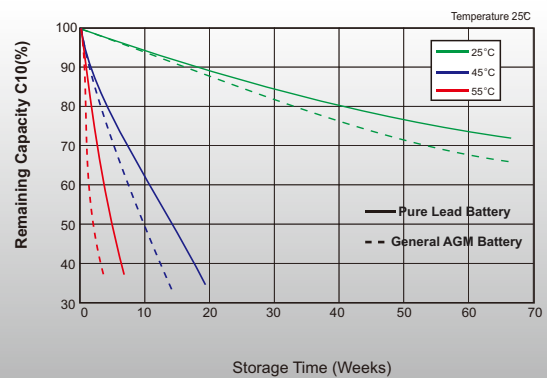

## Sales Offices Worldwide

### China Sales Office

5th Floor, Xinbaohui Bldg., Nanhai Blvd.,  
Nanshan, Shenzhen, China. 518052  
Tel: +86-755-86036060 (100 lines)  
Fax: +86-755-26067269  
E-mail: export@leoch.com

### HongKong Sales Office

Workshop C, 33/F, TML Tower, No. 3 Hoi Shing Road,  
Tsuen Wan, New Territories, Hong Kong  
Tel: +852 35786666  
Fax: +44 1452 690125  
E-mail: sales.hk@leoch.com

### Singapore Sales Office

No. 1 Tech Park Crescent,  
Singapore 638131  
Tel: +65 68636078  
Fax: +65 6863 6079  
Email: sales.sg@leoch.com

### Australia Sales Office

2 /29 Tarlington Place, Smithfield. NSW 2164  
Australia  
Tel: 02 9756 0950  
E-mail: sales.au@leoch.com

### North America Sales Office

19751 Descartes  
Foothill Ranch, CA 92610, USA  
Tel: 949-588-5853  
Fax: 949-588-5966  
E-mail: sales@leoch.us  
Http://www.leoch.us

### UK Sales Office

9B Wheatstone Court. Waterwells, Business Park,  
Gloucester, GL2-2AQ, UK United Kingdom  
Tel: +44(0) 1452 729428 / 1452 729696  
Fax: +44 1452 690125  
E-mail: Sales.Europe@leoch.com  
Http://www.leoch.eu

### EMEA Sales Office

1 Deligiorgi St., 121 31 Athens,  
Greece  
Tel: +30 210 5760318 (2 lines)  
E-mail: support\_EMEA@leoch.com  
Http://www.leoch.eu

### India Sales Office

Shed no.A-53(b), 2nd Stage of Peenya Industrial Area,  
Bangalore North Taluk, Bangalore-560058, India  
Tel: +91-80-23440018/23440019  
Fax: +91-80-23440017  
E-mail: indiasales@leoch.com



[Http://www.leoch.com](http://www.leoch.com)

© 2021 LEOCH. All rights reserved.

Trademarks and logos are the property of LEOCH and its affiliates unless otherwise noted.  
Subject to revisions without prior notice.

Publication No.: LB-PLC100FT-PD-EN-V2.1-202101